

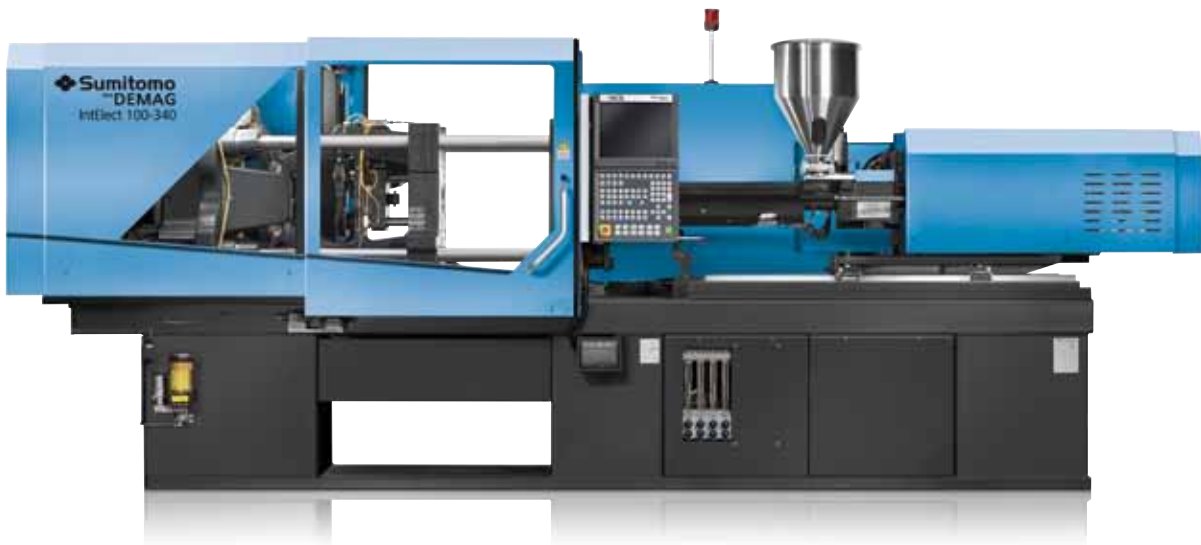

Sumitomo (SHI) Demag Plastics Machinery GmbH
info-dpde@dpg.com
www.sumitomo-shi-demag.eu

IntElect

THE PRECISION MACHINE



 **Sumitomo**
SHI DEMAG

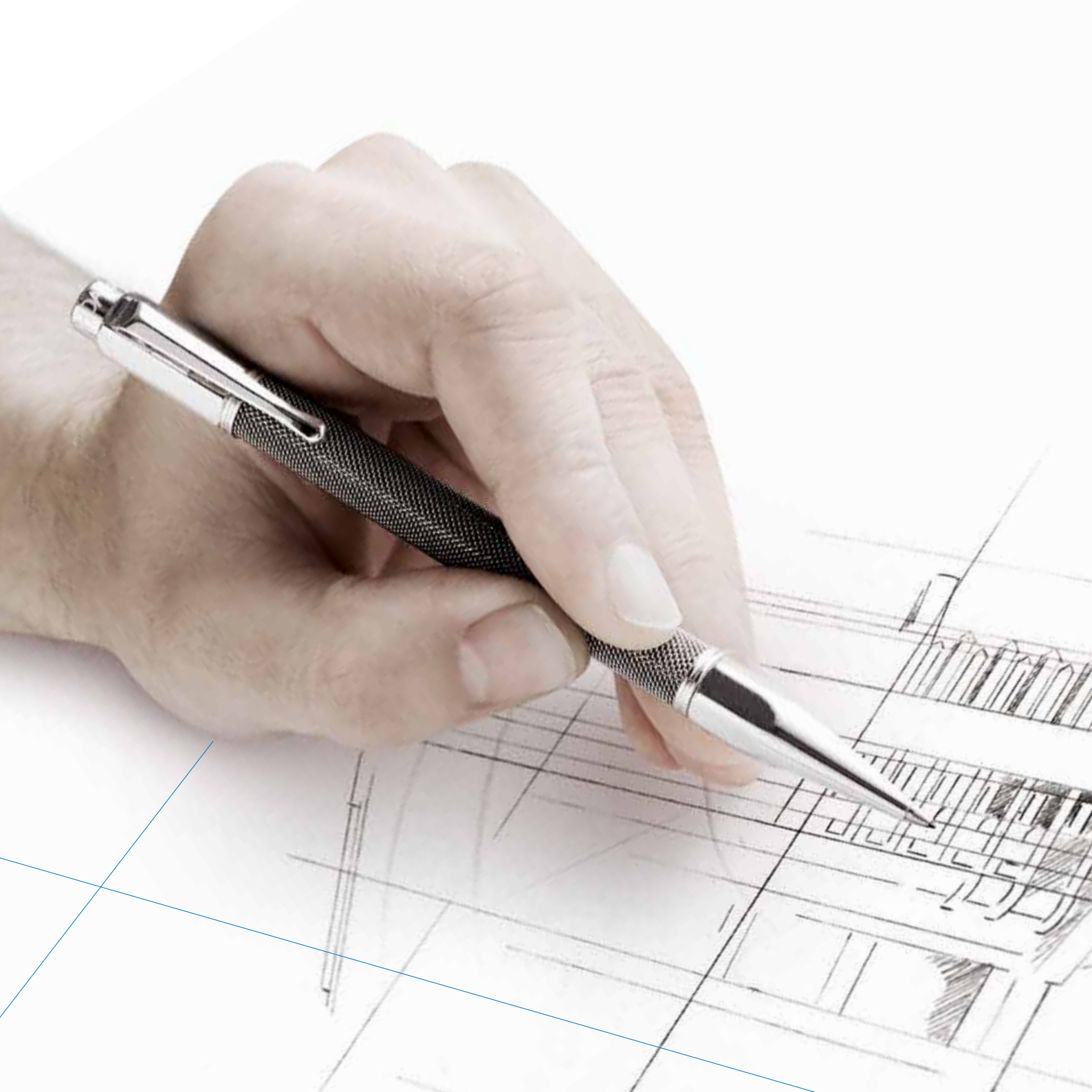

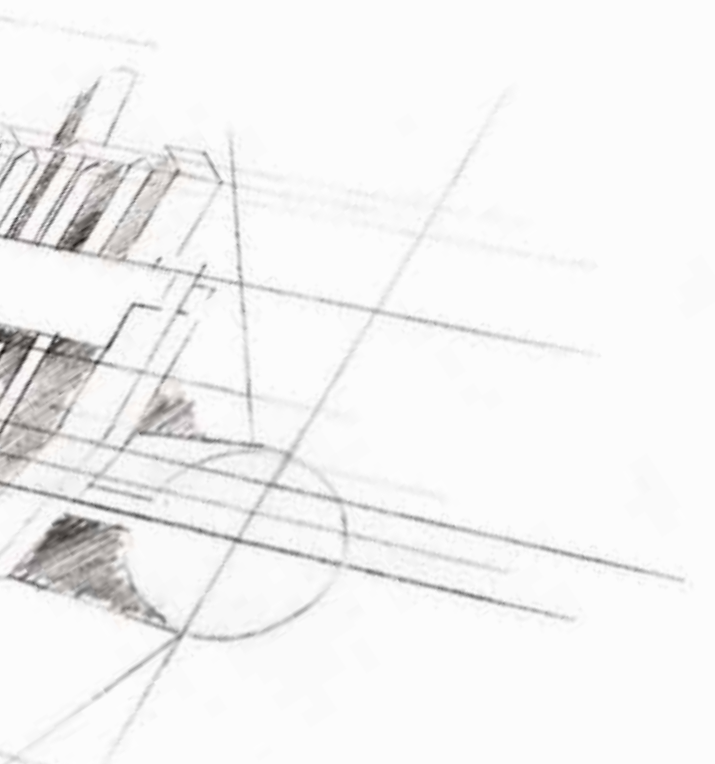

A brilliant idea ...

... stands at the beginning of every successful business deal. Committed and enthusiastic engineers are putting their ideas to paper every day all over the world and their personal success is that one day they will be able to hold the finished product in their hands.

We know this special moment very well and we know how difficult it sometimes is to get there. Sumitomo and Demag have supplied more than 100,000 injection moulding machines all over the world and become familiar with virtually every application and requirement. As early as the 1990s, Sumitomo concentrated on the development and production of fully electronic injection moulding machines and is now one of the world's market leaders and top technology companies. The electric direct drives are developed in-house, optimised for the injection moulding process and also produced by ourselves.

The synergy resulting from the merger between Demag and Sumitomo is particularly evident in the fully electronic injection moulding machine, IntElect. This machine embodies mature drive engineering from Japan with sound mechanical engineering from Germany, combining the best ideas and solutions of our engineers. The result is a highly precise, dynamic and energy-efficient injection moulding machine that will help you successfully bring your ideas to fruition.



- Fast and highly precise clamping unit with dynamic and energy-saving 5-point toggle lever and broad tie bars
- Full compatibility of the different plasticising units that are automatically recognised by the controls when connected to the machine
- Intuitive NC5 control adapted to the injection moulding process, with touch-sensitive colour monitor
- Comprehensive catalogue of options and standardised automation solutions available
- Lower sound impression in comparison with conventional machines, a 50 % reduction in the case of IntElect smart and 75 % in the case of IntElect performance
- Safety, process constancy and precision for demanding jobs with extremely narrow tolerances.

IntElect – The precision machine

IntElect – The precision machine

The fully electronic injection moulding machine, IntElect, builds up on the same machine platform as the hydraulic and hybrid machines from Sumitomo (SHI) Demag. The platform idea is the basis of the product philosophy. This makes innovative solutions available for all product lines - at a price you can afford.

The IntElect is offered in two versions, smart and performance. In both versions the main axes of the clamping unit and the injection unit are driven by fully electronic direct drives.

Low running costs

A major advantage in comparison with hydraulic precision machines is the low energy consumption of the innovative direct drives for the core movements, plasticising, injecting and opening the mould. Furthermore, the braking energy of each main axle is buffered for the energy requirements of the other axes. In this way IntElect saves up to 85 % of the energy consumed by traditional solutions. And because the direct drives convert less energy into heat than hydraulic drives, less cooling capacity is needed than in the case of traditional machines of the same size.

The smart version

- Air-cooled direct drives for the core axes
- Servo-hydraulic nozzle unit
- Belt driven ejector
- Air-cooled drives of particularly low inertia for a low introductory price

The performance version

- Direct drives only:
 - Water-cooled direct drives for the core axes
 - Nozzle unit with direct drive
 - Direct ejector
- Linear guide device as a standard feature
- Optimised for clean room environments up to ISO class 7

Sumitomo
DEMAG
IntElect 100-340

01

05

02

07

04

06

10



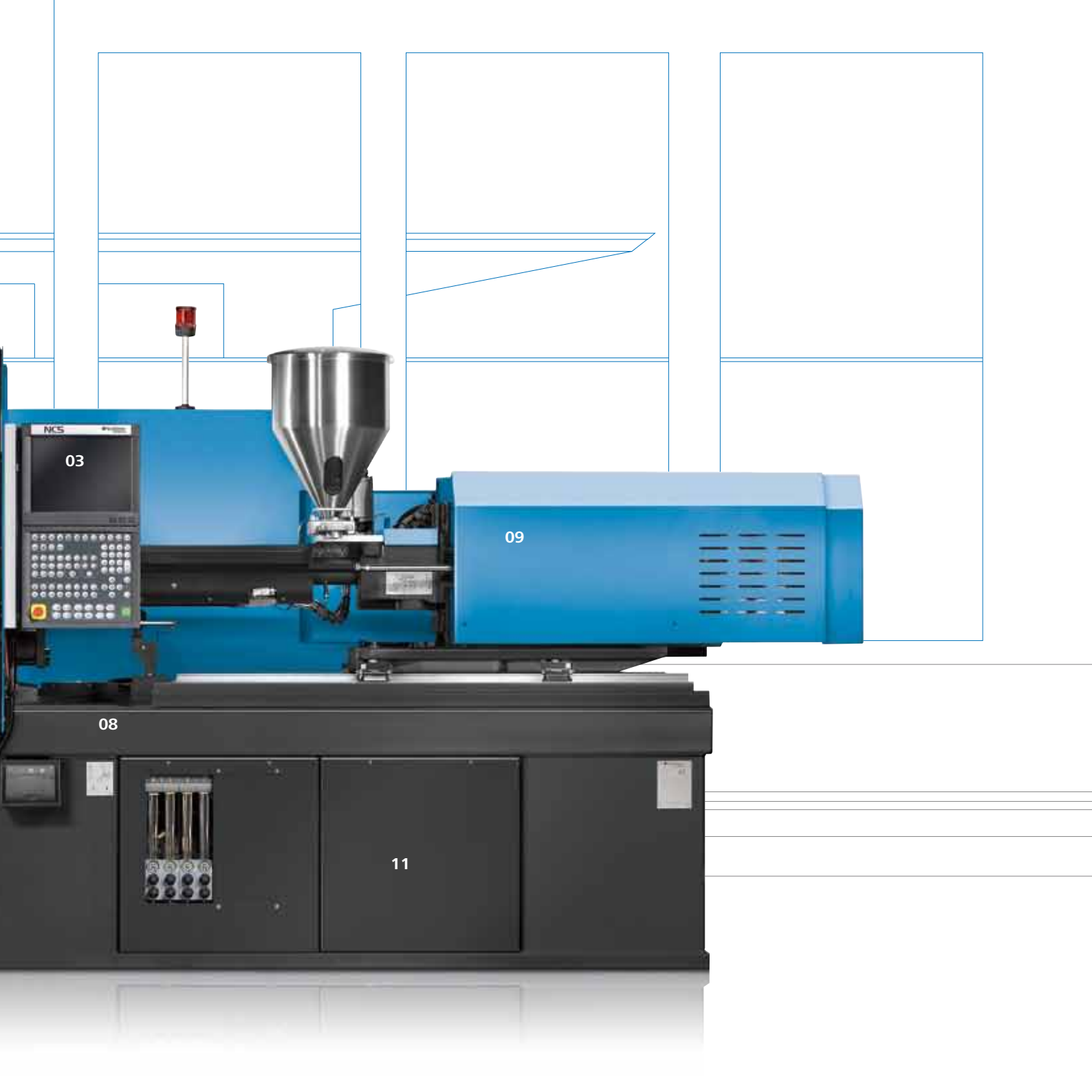

03

09

08

11

- 01 **5-point toggle lever**
with optimum kinematics and computer-optimised braking and acceleration profiles for top precision and energy efficiency
- 02 **High platen parallelism**
for top precision and minimum wear and tear on the mould
- 03 **Intuitive NC5 control**
with process-oriented user interface for comfortable adjustment, monitoring and documentation
- 04 **Active mould protection**
through a high-resolution measurement system with piezoelectric sensors and rapid process signal processing due to the high frequency of the control unit
- 05 **Dynamic and precise clamping unit**
with active energy recovery
- 06 **Guide system of the mobile clamping plate**
for top precision and uninterrupted linear guidance in the case of the performance version
- 07 **Rapid ejector**
for extremely short reaction times and response characteristics, as a belt ejector in the smart version, as a direct ejector in the performance version
- 08 **Compact and robust machine bed**
for top precision and minimum wear and tear on the mould and a long machine service time
- 09 **Efficient injection unit**
with direct drive for top precision and rapid dosage and injection. The constant L/D ratio (20:1) ensures a high degree of homogeneity for the melt, even in the case of difficult colourings. The automatic cylinder detection mechanism guarantees flexibility on exchanging the product and a fast changeover.
- 10 **Wide delivery chute, open on three sides**
for a flexible flow of material and easy integration of the peripheral components
- 11 **Free space**
for a hydraulic module that can be integrated into the machine bed with low noise development. It can be used flexibly for several machines.



Dynamic and energy efficient

Dynamic and energy efficient

The heart of the clamping unit is the electrical direct drive – air-cooled in the case of the IntElect smart and water-cooled in the case of the IntElect performance.

The advantages of the closing motor on the end plate are its very high dynamism and precision and its short reaction time. A lubrication system guarantees an efficient supply of lubricant.

The transmission of force to the moving platen is effected by the 5-point toggle lever. Its powerful kinematics ensure short locking times and enormous tearing force. The closing and opening motions are very sensitively controlled and gentle on the mould. Furthermore, on the braking of the clamping unit, the kinetic energy is regained and made available for the energy-intensive plasticising process.

Precise and gentle on the mould

Any extremely rigid machine bed construction is the foundation of all Sumitomo (SHI) Demag machines. Great value is placed on exactness, stability and the lowest possible warpage of the machine bed under the heaviest loads.

In combination with the stationary platens, the parallel flow of force through the tie bars and the linear guidance, which is a standard feature of the performance version, makes the IntElect an extremely precise injection moulding machine which is gentle on the mould.

And if there should be any irregularities on closure, the integrated, highly sensitive mould protection mechanism ensures that no damage is done to the mould.

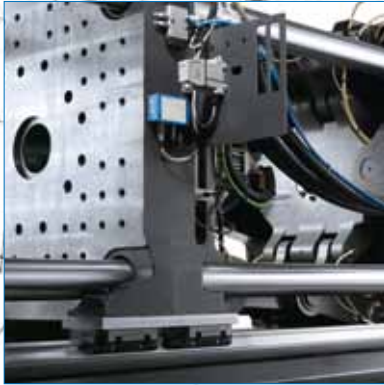

Precise and gentle on the mould



Fast and accurate



Powerful and flexible

Fast and accurate

In the smart version the ejector of the IntElect functions by means of drive belt. In the performance version a direct ejector is used. This is first choice when the machine is used under special clean room conditions.

Both types of ejector are optimised in relation to force, accuracy and dynamism for the injection moulding process. The speed and the position profile are freely adjustable.

Powerful and flexible

The injection unit of the IntElect owes its efficiency to the direct drives. Its aggressive acceleration capacity forms the basis for high precision and repeat accuracy. The servo-hydraulic nozzle unit system of the smart version combines the high force density of a hydraulic system with the optimum controllability of an electric system.

It is completely encapsulated and provides a highly efficient and virtually torque-free nozzle unit. The automatic cylinder detection mechanism facilitates the change of the plasticising unit and guarantees a rapid changeover and flexibility when exchanging the product.

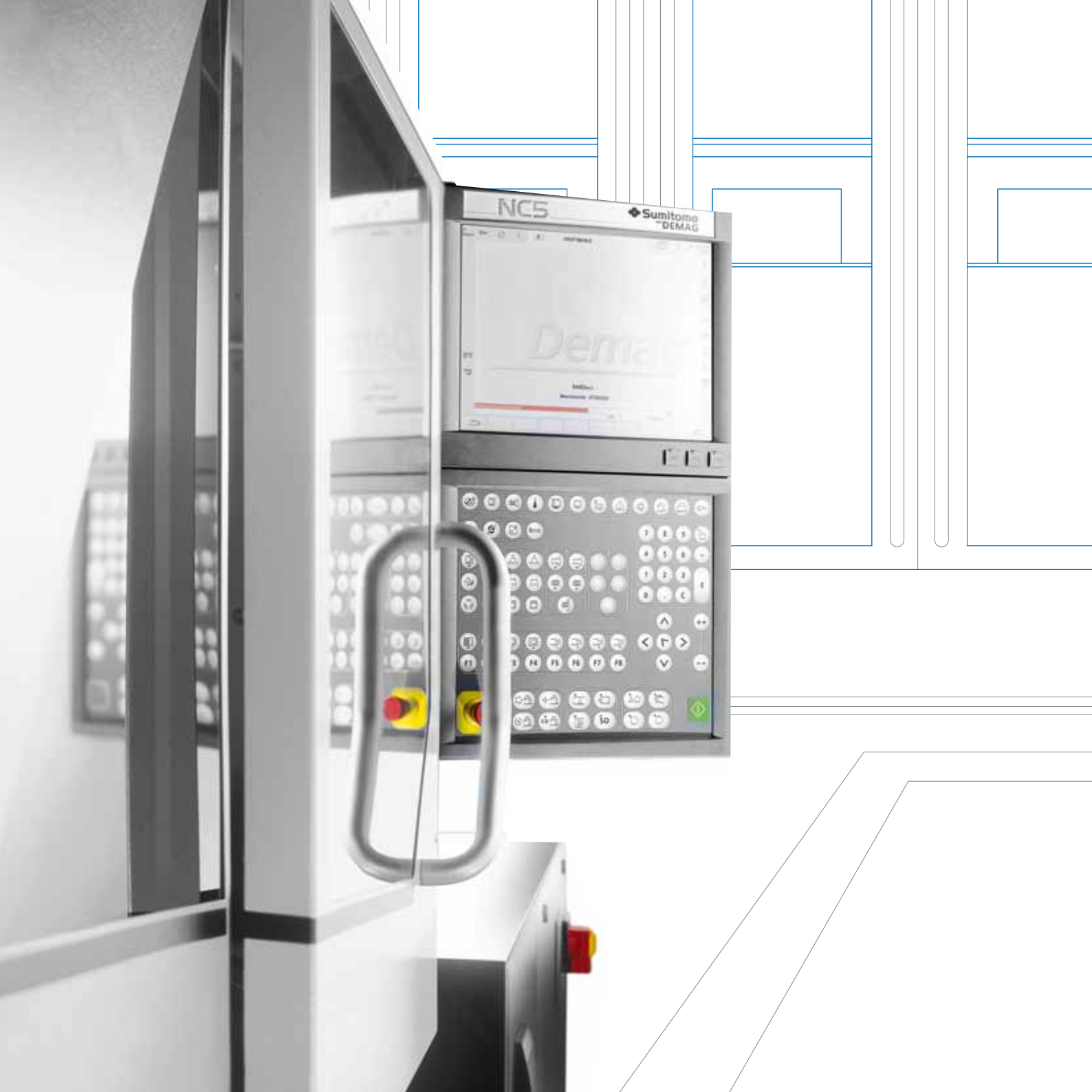

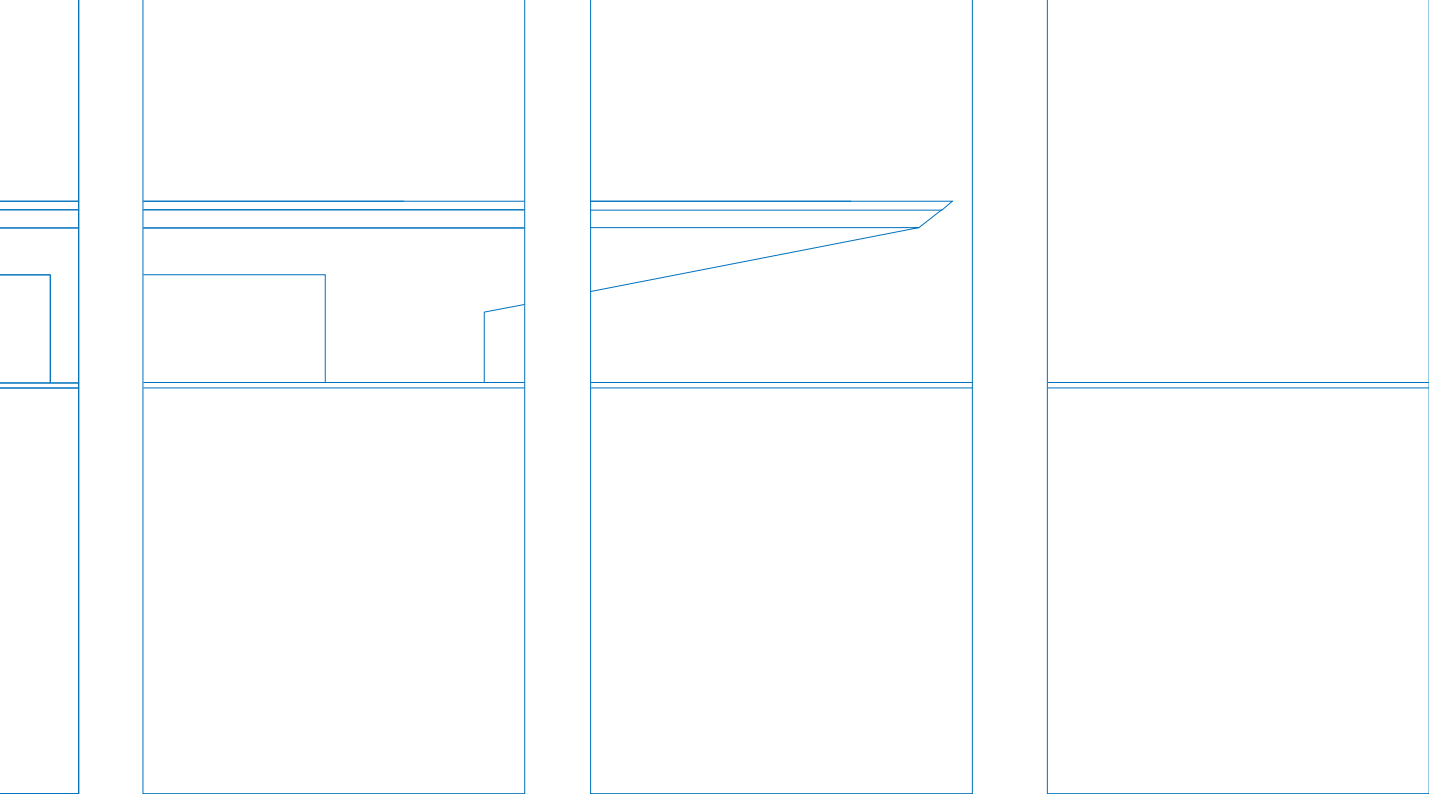

NC5 – The intuitive command centre

In the production process the machine control unit plays a decisive role as the interface between human beings and the machine. The NC5 control unit, which is a standardised feature for all machines, therefore forms an important part of the platform philosophy of Sumitomo (SHI) Demag.

- The core principle of the NC5 design is the visualisation of the injection process, which can be learned intuitively and controlled by means of a touch screen. This greatly facilitates the operation of the machine.
- Further highlights of the NC5 are user-defined pages, hot keys and the integrated control of peripheral devices and special equipment.
- Data exchange and the backup of the valuable process parameters take place via integrated USB Interfaces.
- The remote maintenance module, world connect, allows external access by specialists.
- The optional module for connection to the master computer links the machine to the control centre of your manufacturing plant.
- The "classic mode" of the NC5 control unit enables the user to adjust the display screen so that it has the tabular appearance of the predecessor model of the NC4 control unit. This helps users become familiar with the new control unit and saves valuable time.



Electronics – fast and energy-saving:
Fluorescent tube holder



Packaging – precise and with high repeat accuracy while being very gentle on the mould: spray head



Medical technology in the clean room – safe and economical: inhaler



Automobile – zero errors for just-in-time: connector

Ultimately only the result counts ...

... so it is important to know that you have a reliable partner at your side – the IntElect is ideal for this and combines the various experience gained from more than 100,000 machines installed throughout the world. Due to the perfect synthesis of direct drives, machine engineering and the exact control of plasticising, injection and mould movements the IntElect achieves a high degree of process constancy and accuracy.

Whether it is a question of automotive engineering, electronics, medical technology and clean room applications, packaging or microtechnology – the IntElect is the ideal machine for all moulded parts where a high degree of dimensional stability and repeat accuracy is essential.

And as partnerships always have an individual touch and are shaped by human beings, it is good to know that the committed staff of Sumitomo (SHI) Demag are right behind the IntElect and are looking forward to giving you all the support you need.